

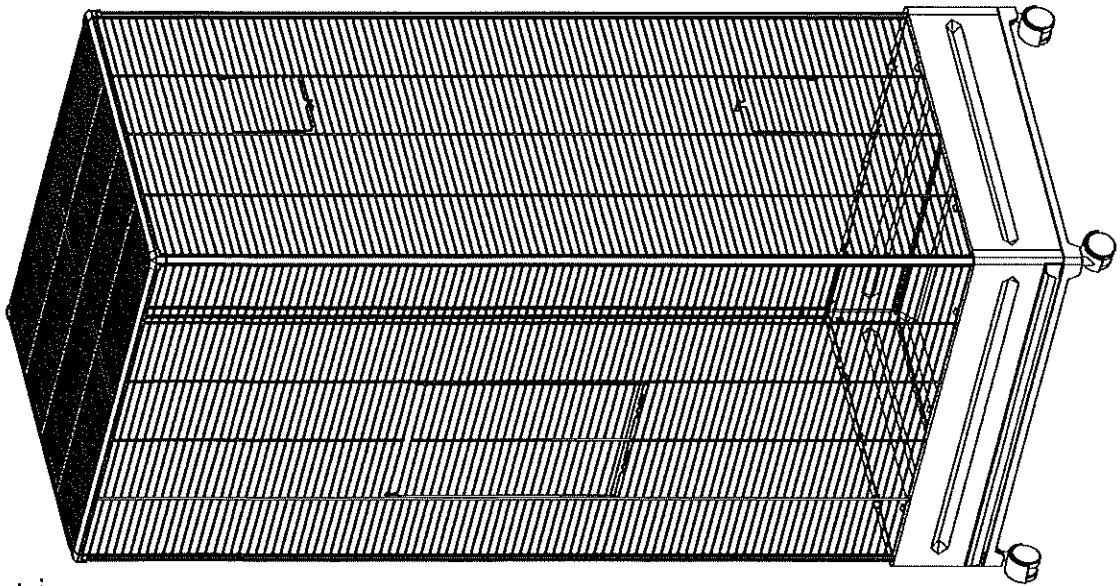

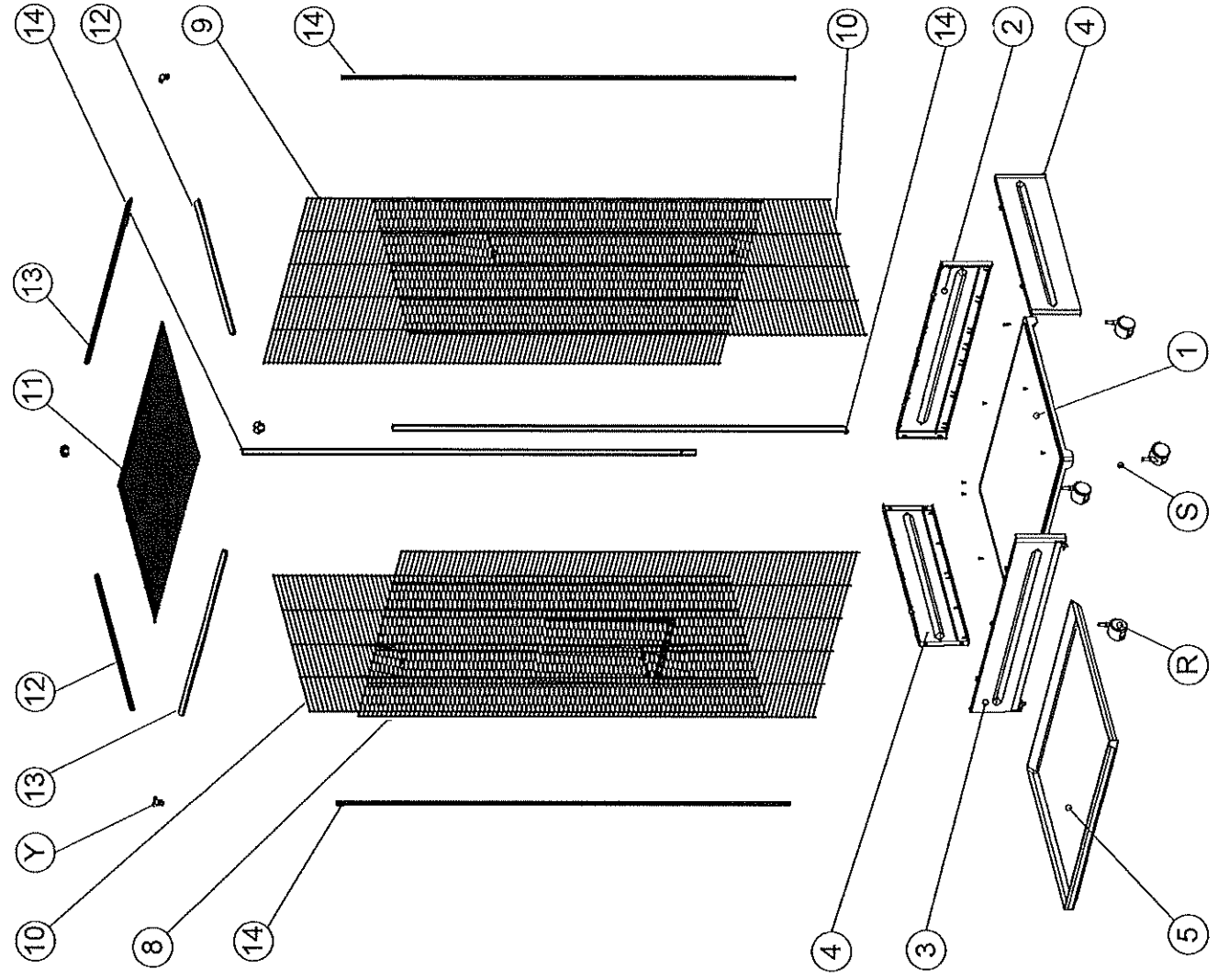



420
65.5X54X150cm.



| | |
|---|----|
|  | x4 |
|  | x2 |
|  | x2 |

| | |
|---|-----|
|  | x4 |
|  | x11 |
|  | x4 |

